

1

Choose an image which includes white – everything white will glow!  
Select normal print quality and a plain or photo paper setting.  
Print on the blank side of the transfer paper, one sheet at a time

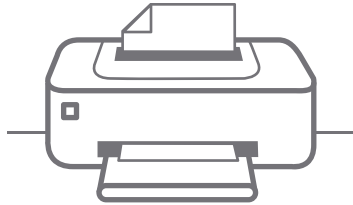

Print on the blank/unprinted side of the transfer paper



2

Trim around or contour cut the image  
Note: This paper has a white film background



**SILHOUETTE BLADE SETTING\*** 2  
SPEED 3 THICKNESS 4

\*Adjust as necessary. Use a cutting mat (carrier sheet) and cut through the film layer only

3

Peel off backing paper



4

Pre-heat iron for **3 minutes** on the highest cotton setting



5

Choose a smooth hard surface at waist level



6

Place image face up on substrate and cover with a Teflon or silicone sheet

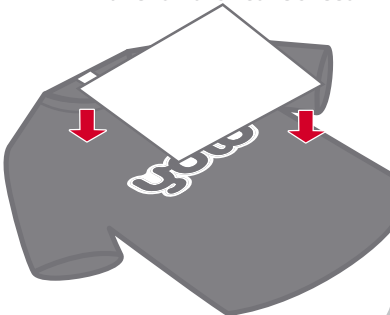

7

Using two hands firmly slide the iron vertically up and down

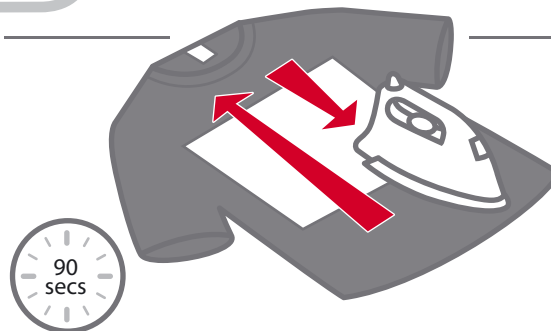

The iron should be halfway off the edge of the transfer when the edges are ironed

In **90 seconds** the iron should make two passes over the surface of the transfer



8

Using two hands firmly slide the iron horizontally side to side

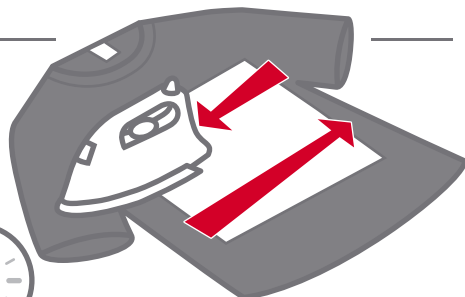

The iron should be halfway off the edge of the transfer when the edges are ironed

In **90 seconds** the iron should make two passes over the surface of the transfer



9



Peel when warm\*

24hrs before washing

\*After approximately 10 seconds

1

Choose an image which includes white – everything white will glow!  
Select normal print quality and a plain or photo paper setting.  
Print on the blank side of the transfer paper, one sheet at a time



Print on the blank side of the transfer paper (side without grid)

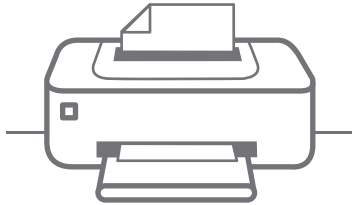

2

Trim around or contour cut the image  
Note: This paper has a white film background



**SILHOUETTE**  
**BLADE SETTING\*** 2  
**SPEED 3** **THICKNESS 4**

\*Adjust as necessary. Use a cutting mat (carrier sheet) and cut through the film layer only

3

Peel off backing paper



4

Prepare the heat press at 160°C / 320°F

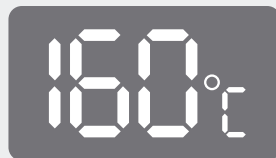

5

Place image face up and cover with supplied silicone sheet

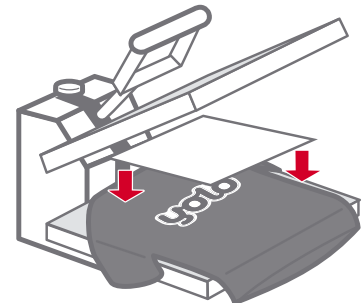

6

Apply **medium** pressure for **40 seconds**

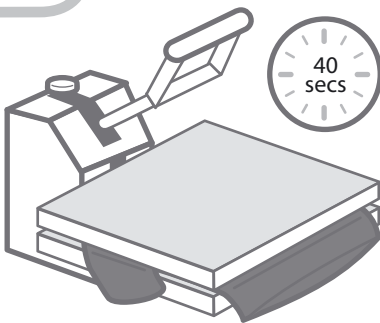

7



Peel when warm\*

24hrs before washing

\*After approximately 10 seconds

**yolo tip**

Repressing for 5-7 seconds with a Teflon or silicone sheet (peel cold) and lightly stretching the transfer when warm will increase softness and durability

**wash and care instructions**



Machine wash separately



Dry at low heat setting



Do not dry clean, bleach or directly iron transfer



Store in a cool, dry place and seal the packaging between uses

**contact**

hello@yolo.co.uk

+44 (0) 2082 400 658

www.yolo.co.uk

Product code: PHOG

Printed on 100% recycled paper