

1

Mirror your image or artwork



2

Cut your image using a contour/plotter cutter, ensuring the blade cuts through the film only and not the release liner

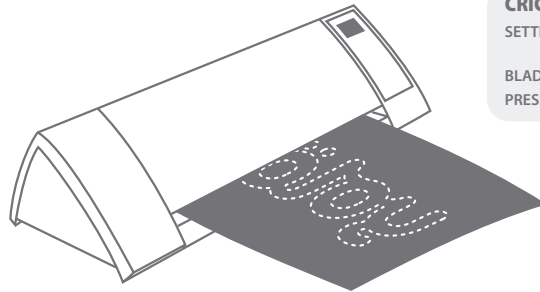

CRICUT GUIDELINES*

SETTING **Flocked Iron On**
(optional additional pressure)
BLADE **Standard Fine Cut**
PRESSURE **Default/Added Pressure**

SILHOUETTE
BLADE SETTING* **3**
SPEED 5 THICKNESS 33

*Adjust as necessary. Use a cutting mat (carrier sheet) and cut through the film layer only. Test cuts are recommended.

3

Weed away the unwanted film, leaving the image on the release liner (a weeding tool may help)

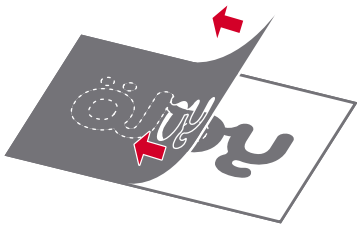

4

Pre-heat iron for **3 minutes** on the highest cotton setting

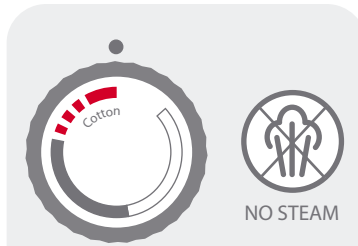

5

Choose a smooth hard surface at waist level



6

Place image face down on substrate and cover with a Teflon or silicone sheet

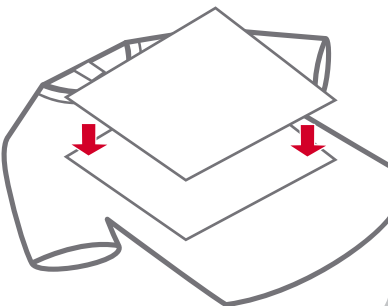

7

Using two hands firmly slide the iron vertically up and down

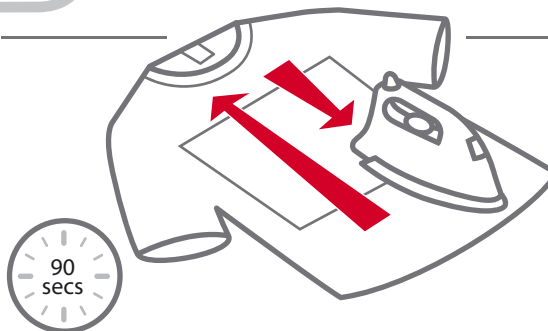

The iron should be halfway off the edge of the transfer when the edges are ironed

In **90 seconds** the iron should make two passes over the surface of the transfer



8

Using two hands firmly slide the iron horizontally side to side

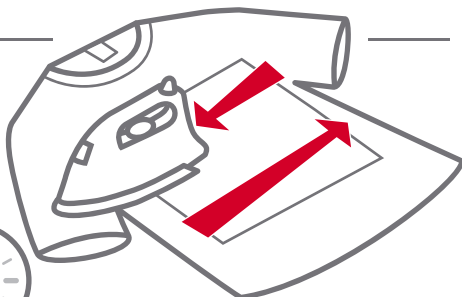

The iron should be halfway off the edge of the transfer when the edges are ironed

In **90 seconds** the iron should make two passes over the surface of the transfer



9



Peel when warm*

24hrs before washing

*After approximately 10 seconds

1

Mirror your image
or artwork



2

Cut your image using a contour/plotter cutter, ensuring the blade
cuts through the film only and not the release liner

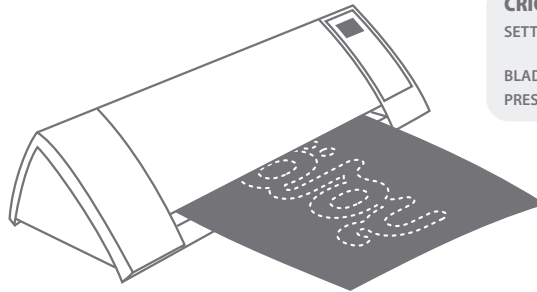

CRICUT GUIDELINES*

SETTING **Flocked Iron On**
(optional additional pressure)
BLADE **Standard Fine Cut**
PRESSURE **Default/Added Pressure**

SILHOUETTE
BLADE SETTING* **3**
SPEED 5 THICKNESS 33

*Adjust as necessary. Use a cutting mat (carrier sheet) and cut through the film layer only. Test cuts are recommended.

3

Weed away the unwanted
film, leaving the image on
the release liner
(a weeding tool may help)

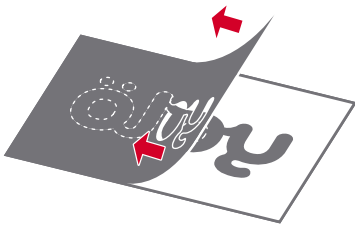

4

Prepare the heat press at
165°C / 330°F

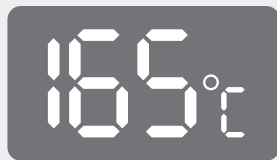

5

Place image face down
on substrate

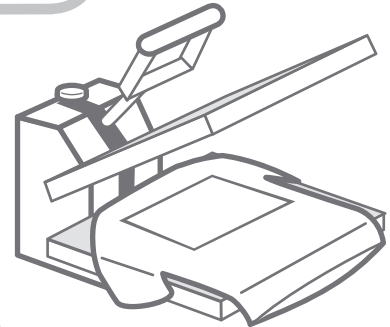

6

Cover with a Teflon or
silicone sheet

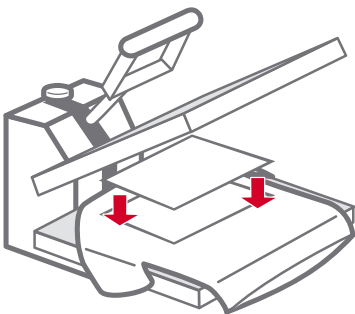

7

Apply **medium** pressure
for **17 seconds**

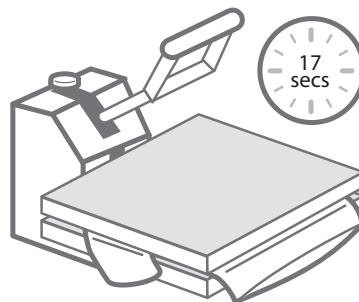

8



Peel
when
warm*

24hrs
before
washing

*After approximately 10 seconds

wash and care instructions



Machine wash
separately



Dry at low heat
setting



Do not bleach or
directly iron image

contact

✉ hello@yolo.co.uk

☎ +44 (0) 2082 400 658

🌐 www.yolo.co.uk

Product code: **VEVO (EVO)**

! Store in a cool, dry place and seal the packaging between uses